

LAVAMAT W 730

Washing Machine

User information



Dear Customer,

Please read this user information carefully.

Pay particular attention to the section "Safety" on the first Info pages.

Please keep this user information in a safe place for later reference.

Pass it on to any future owners of the unit.



The warning triangle and /or signal words (**Warning!**, **Caution!**, **Important!**) emphasise information which is important for your safety or for the unit's functional reliability. It is imperative that this information is observed.



1. This symbol guides you step by step through the operation of the appliance.

2. ...



Next to this symbol you will find additional information and practical tips on using the appliance.



Tips and information on economical and environmentally responsible use of the unit are identified with the clover leaf.

For any faults which occur, this user information contains information on how to remedy these faults yourself. See the section "What to do if ..."

Printed on recycled paper.

Thinking ecologically means acting ecologically.

CONTENTS

Operating Instructions	6
Safety	6
Disposal	8
Environmental tips	8
Unit description	9
Front view	9
Drawer for Washing Powder and Care Agent	9
Control Panel	10
Programme Knob	10
Temperature Selector	12
Additional Programme Buttons	12
⓪ (ON/OFF) button	13
Consumption values and time requirements	14
Before the First Wash	14
Prepare washing cycle	15
Sort washing and prepare	15
Washing Types and Care Symbols	16
Washing Detergents and Care Agents	17
Which detergent and care agent?	17
How much detergent and care agent?	17
Water Softener	17
Running a Wash Cycle	18
Brief Instructions	18
Add the washing	18
Add Washing Detergent and/Care Agent	19
Setting the Wash Programme	20
Changing the Spin Speed/Selecting Rinse Hold	21
Start the Wash Programme	21
Wash Programme Progress	22
Changing/Interrupting the Wash Programme	22
Wash Cycle Completed/Removing Washing	23

Programme Tables	24
Washing	24
Separate Rinse	25
Separate Conditioning/Starching/Finishing	25
Separate Spin	25
Cleaning and Care	26
Control panel	26
Detergent Drawer	26
Washing Drum	27
Main door	27
Cleaning the drain pump	28
What to do if	29
Remedying Faults	29
If the washing results are not satisfactory	32
Carrying out emergency drainage	32
Child Safety Feature	34
Installation and connection instructions	35
Installation Safety Precautions	35
Installation of the appliance	36
Transporting the appliance	36
Remove transportation protection	36
Prepare the installation place	38
Installation on a concrete base	38
Installation on vibrating floors	38
Compensate for floor unevenness	39

Electrical connection	40
Water connection	40
Permissible water pressure	40
Water inflow	41
Water drain	42
Delivery heads over 1m	43
Technical data	43
Dimensions	43
Warranty conditions / Customer service centres	44
Index	50
Service	51

Operating Instructions



Safety

The safety aspects of AEG electrical appliances comply with accepted technical standards and the German Appliance Safety Law. However, as manufacturers we regard it as our responsibility to inform you about the following safety instructions.

Before Using for the First Time

- Refer to the "Installation and Connection Instructions" further on in this user information.
- If units are delivered in the winter months at minus temperatures: Store the washing machine at room temperature for a few hours before putting it into operation.

Correct Use

- The washing machine is only intended for washing normal domestic washing. If the appliance is used for a wrong purpose or wrongly operated, the manufacturer cannot assume any liability for any damages.
- Additions or modifications to the washing machine are strictly forbidden due to safety reasons.
- Use only detergent which is suitable for washing machines. Refer to the detergent manufacturer's instructions.
- The washing must not contain any flammable solvents. Also bear this in mind when washing pre-cleaned washing.
- Do not use the washing machine for dry-cleaning.
- Dyes /dye-removing agents may only be used in the washing machine if the manufacturer expressly permits use of these products. We cannot accept liability for any damage.
- Use only water from the water mains. Use rain water or service water only if it meets the requirements defined in DIN 1986 and DIN 1988.
- Frost damage is not covered by the warranty! If the washing machine is in a room subject to possible frost hazards, emergency emptying must be carried out if there is a risk of frost (see the Section "Carrying out emergency emptying").

Child Safety

- Packaging materials (e.g. films, polystyrene) can be dangerous for children. Risk of suffocation! Keep packaging away from children.
- Children frequently cannot recognise hazards involved in handling electrical appliances. Therefore, ensure that they are properly supervised during operation and never allow children to play with the washing machine – there is a risk that they can lock themselves inside it.
- Ensure that children or small animals do not climb into the washing machine's drum.
- When disposing of washing machines pull out the mains plug, destroy the door lock, cut off the electrical supply lead and dispose of the plug and remaining cable. This means that playing children cannot shut themselves in and cannot encounter a potentially lethal hazard.

General Safety

- Repairs to the washing machine may only be carried out by qualified specialists. Incorrect repairs may result in significant risk to the user. If repairs are necessary, consult our customer service or your specialist dealer.
- Never use the washing machine if the mains cable is damaged or the control panel, work surface or base panel area are so badly damaged that the interior of the unit is openly accessible.
- Switch off the washing machine before carrying out cleaning, care and maintenance work. Also pull the mains plug out of the socket or, – if it is permanently connected, – switch off the circuit breaker at the household power distribution box or completely remove the screw-in fuse.
- Never pull the cable to remove the plug from the socket. Always pull the plug itself.
- Multiple connectors, couplings and extension cables must not be used. **There is a risk of fire with overheating!**
- Do not spray down the washing machine with a water jet. Risk of electric shock!
- The glass in the door becomes hot in the case of wash programmes with high temperatures. Do not touch!
- Allow the washing solution to cool before carrying out an emergency emptying operation or cleaning the drain pump.
- Small animals can chew the power cables and water hoses. Risk of electric shock and danger of water damage! Keep small animals away from the washing machine.



Disposal

Disposing of the Packaging Material!

Dispose of the packaging of your washing machine correctly. All packaging materials used are environmentally-compatible and recyclable.

- Plastic parts are identified with internationally standardised abbreviations:
 - >PE< for polyethylene, e.g. packing films.
 - >PS< for polystyrene, e.g. cushion parts (always CFC-free)
 - >POM< for polyoxymethylene, e.g. plastic clips.
- Cardboard packaging is manufactured from recycled paper and should be deposited in the waste paper collection for recycling.

Disposing of your old appliance!

When you put your unit out of operation one day, please bring it to your nearest recycling centre or to your dealer.



Environmental tips

- A pre-wash cycle is not necessary in the case of washing which is not excessively dirt. This saves detergent, water and time (and is gentle on the environment.)
- If the indicated load capacities are taken full advantage of, the washing machine is especially efficient.
- For small loads, use only one half to one third of the recommended detergent quantity.
- Suitable pre-treatment enables marks and limited amounts of dirt to be removed. You can then wash at a lower temperature.
- Wash slightly to normally dirty cottons with the energy-saving program.
- There is often no need for the softener. Try it once! If you use a drier, your washing will become soft and fluffy even without a softener.
- In the case of medium to high water hardness (hardness range runs to upwards, see "Detergent and care agents"), you should use a water softener. The detergent can then always be metered for hardness range I (= soft).

Unit description

Front view

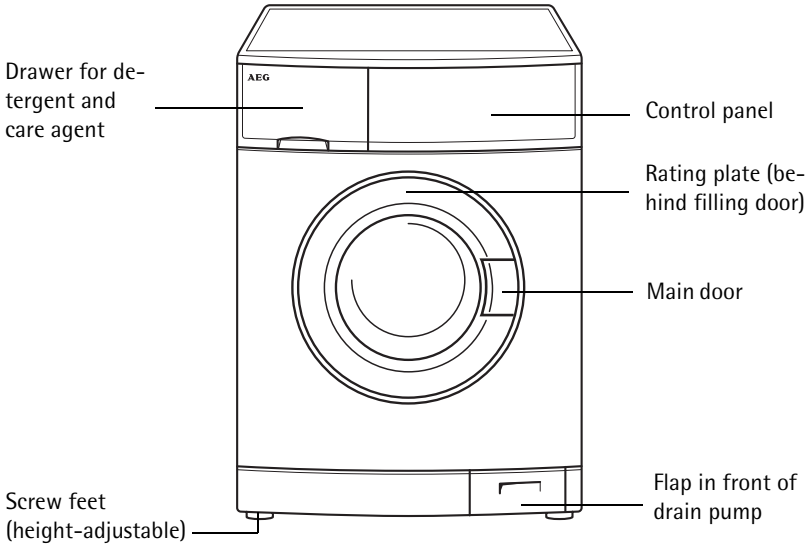

Drawer for Washing Powder and Care Agent

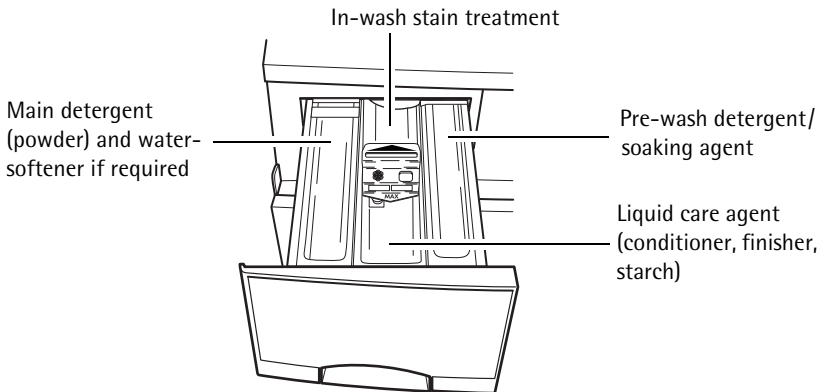

Control Panel

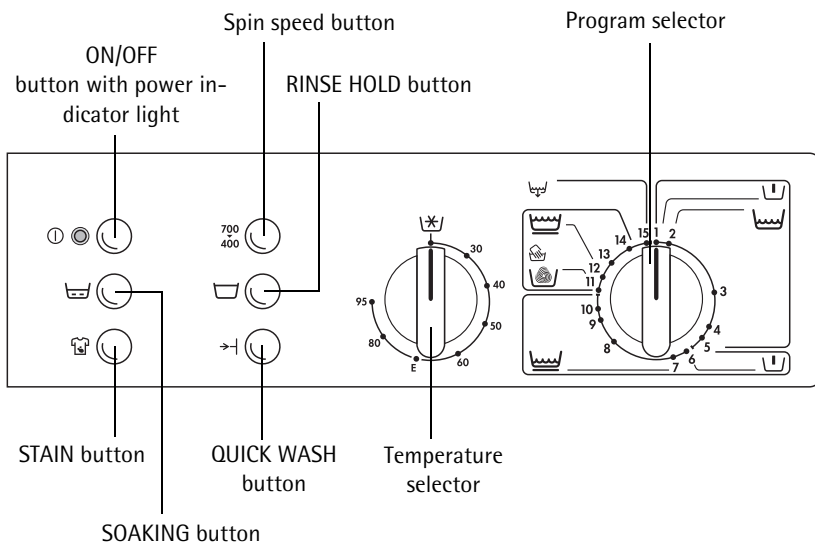

Programme Knob

The programme knob determines the type of wash cycle (eg. water level, drum movement, number of rinses, spin speed) according to the type of the articles to be washed.

Important! Only turn the programme knob in a clockwise direction!

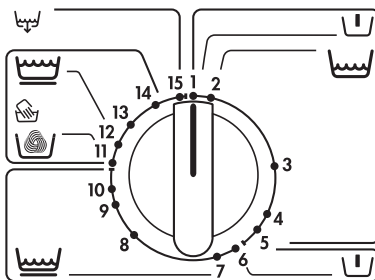

Programme group (COTTONS/LINEN)

1 (PRE WASH)

Pre wash for cottons/linen (approx. 30 minutes, temperature limited to a maximum of 40 °C). The main wash follows immediately afterwards.

2 (COTTONS/LINEN)

Main wash cycle for cottons/linen (cold up to 95 °C).

3 (RINSE)

Separate rinse followed by spin or rinse hold, eg. for rinsing hand-washed cottons/linen.



Rinse hold means: The washing remains lying in the last rinsing water. It is not spun.

4 (CONDITIONER)

Separate conditioning, separate starching or separate finishing for damp cottons/linen (1 rinse, liquid care agent is flushed in from the compartment  followed by spin or rinse hold).

5 (SPIN)

Spin after rinse hold or separate spin for handwashed cottons/linen.

Programme group  (EASY-CARES)** 6 (PRE WASH)**

Pre wash for easy-care textiles (approx. 30 minutes, temperature limited to a maximum of 40 °C). The main wash cycle follows automatically.

 7 (EASY-CARES)

Main wash cycle for easy-care textiles (cold to 60 °C).

8 (RINSE)



Separate rinse followed by spin or rinse hold, eg. for rinsing hand-washed easy-care articles.

9 (CONDITIONER)

Separate conditioning, separate starching or separate finishing for damp easy-care textiles (1 rinse, liquid care agent is flushed in from the compartment  followed by spin or rinse hold).

10 (SPIN)

Spin after rinse hold or separate spin for handwashed easy-care articles, woollens and delicates.

Programme group  (WOOLLENS)/ (DELICATES)**/ 11 (WOOLLENS)**

Main wash cycle for woollens and particularly delicate textiles (cold to 40 °C).

 12 (DELICATES)

Main wash cycle for delicates (cold to 40 °C).

13 (GENTLE RINSE)

Separate gentle rinse followed by short spin or rinse hold, eg. for rinsing hand-washed woollens or delicates.

14 (CONDITIONER)

Separate gentle conditioning for damp woollens or delicates (1 gentle rinse, liquid care agent is washed in from the compartment  followed by short spin or rinse hold).

15 (PUMP OUT)

Water pumped out without spin, eg. after rinse hold.

Temperature Selector

The following settings are possible:
 (COLD), 30, 40, 50, 60, E, 80, 95 °C.



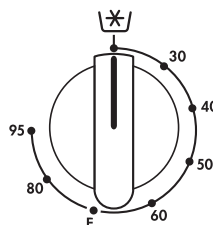

Position E (Energy-saving programme)
 Instead of a wash cycle at 95 °C the energy-saving programme at approx. 70 °C can be used for lightly or normally soiled cottons.



Additional Programme Buttons

The additional programme buttons are for suiting the wash programme to the dirtiness of the washing. Additional programmes are not required for washing which is not excessively dirty.



The additional programmes can only be used in conjunction with programmes for the programme groups  (COTTONS/LINEN) and  (EASY-CARES).



(SOAKING)

Soaking time approx. 35 minutes;
 Temperature limited to a maximum of 40 °C.



 (SOAKING) can be used in conjunction with programme knob settings:

-  1 (PRE WASH COTTONS/LINEN);
-  6 (PRE WASH EASY-CARES).





At the end of the soaking programme the washing will remain in the washing solution until you release the  (SOAKING) button by pressing again. The main wash cycle for  (COTTONS/LINEN) or  (EASY-CARES) will follow.

(STAIN)

For dealing with heavily soiled or stained washing (in-wash stain treatment is added at the optimum time during the course of the programme).



 (STAIN) can be used in conjunction with the programme knob settings:

-  1 (PRE WASH COTTONS/LINEN);
-  2 (COTTONS/LINEN);
-  6 (PRE WASH EASY-CARES);
-  7 (EASY-CARES).

→| (QUICK WASH)

Shorter washing cycle for lightly soiled washing.

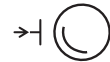

→| (QUICK WASH) can be used in conjunction with the programme knob settings:

-  2 (COTTONS/LINEN);
-  7 (EASY-CARES).







① (ON/OFF) button

Pressing the ① (ON/OFF) button switches the washing machine on and starts the selected programme. Pressing the button again switches the washing machine off.



Consumption values and time requirements

The values for selected programmes in the following tables were determined under standardized conditions. They are nonetheless a useful guide for domestic use.

Programme knob	Temperature selector	Filling quantity in kg	Water in litres	Energy in kWh	Time in minutes
 2 (COTTONS/LINEN)	95	5	57	1.90	140
 2 (COTTONS/LINEN)	60 ¹⁾	5	54	0.95	128
 2 (COTTONS/LINEN)	40	5	54	0.60	115
 7 (EASY-CARES)	40	2.5	45	0.40	65
 12 (DELICATES)	30	2.5	40	0.25	40
 11 (WOOLLENS)	30	2	43	0.25	50

1) **Information:** Programme setting for a test in accordance with EN 60 456. The consumption values can deviate from the stated values depending on the water pressure, hardness, inlet temperature, room temperature, type and quantity of washing, the detergent powder/liquid used, fluctuations in the mains voltage and selected additional functions.

Before the First Wash

1. Pull the washing powder drawer out slightly.
2. Pour about 1 litre of water through the washing powder drawer into the washing machine. The next time a programme is started the solution container will be closed and the eco-sluice can function correctly.
3. Run one wash cycle without washing:
 - Programme knob on Position  2 (COTTONS/LINEN);
 - Temperature 95 °C;
 - Only add half the quantity of detergent recommended by the manufacturer for a full load.
 This removes residues left over from manufacture on the drum and solution container.

Prepare washing cycle

Sort washing and prepare

- Sort the washing according to the care symbol and type (see "Washing types and care codes").
- Empty all pockets.
- Remove metal objects (paper clips, safety pins etc.).
- To prevent damage to the washing and tangled washing: Close zip fasteners, button bed and pillow covers closed, tie up loose strings e.g. of aprons.
- Turn articles with double layered textiles inside out (sleeping bags, anoraks etc.).
- In the case of knitted coloured textiles and also with wool and textiles with jewelry attached: turn inside out.
- Wash small and sensitive items (e.g. baby socks, tights and stockings, bras etc.) in a washing net, a cushion with a zip fastener or in larger socks.
- Handle curtains with particular care. Metal rollers or burred, plastic rollers must be removed or tied into a net or bag. We cannot accept liability for damage.
- Coloureds and white items must not be washed together in a washing cycle. This could discolour white washing or turn it grey.
- There is often excess dye in new, coloured items. It is best to wash such items separately the first time.
- Mix small and large items. This improves the washing effect and the washing is more favourably distributed during spinning.
- Fluff washing before placing into the washing machine.
- Do not place folded washing into the drum.
- Pay attention to the care instruction "wash separately" and "wash separately several times".

Washing Types and Care Symbols

The care symbols help you choose the correct wash programme. The washing should be sorted according to type and care symbol. The temperatures stated in the care symbols are all maximum values.

Cottons

Textiles made of cotton and linen with this care symbol are resistant to mechanical stress and high temperatures. The  (COTTONS/LINEN) programme is suitable for this type of washing.

Linen

Textiles made of cotton and linen with this care symbol are resistant to mechanical stress. The  (COTTONS/LINEN) programme is suitable for this type of washing.



Easy-care washing

Textiles such as finished cotton, cotton mixtures, viscose and synthetics with these care symbols require gentler mechanical treatment. The  (EASY-CARES) programme is suitable for this type of washing.

Delicates

Textiles such as fibre blends, microfibres, viscose, synthetics and net curtains with this care symbol need particularly gentle treatment. The  (DELICATES) programme is suitable for this type of washing.

Woollens and particularly delicate washing

Textiles such as wool, wool mixtures and silk with these care symbols are especially sensitive to mechanical stress. The / (WOOLLENS) programme is suitable for this type of textile.

Important! Textiles with the care symbol  (Do not wash!) must not be washed in the washing machine!

Washing Detergents and Care Agents

Which detergent and care agent?

Use only detergents and care agents which are suitable for use in washing machines. Always follow the manufacturer's instructions.

How much detergent and care agent?

The amount to be used depends on:

- the dirtiness of the washing
- the hardness category of the mains water supply
- the quantity of washing



If the detergent manufacturer does not include dosing instructions for reduced loads, use one third less for half loads and only half of the full load detergent quantity for very small loads.

Refer to the detergent/care agent manufacturer's instructions on use and dosage.

Water Softener

For medium to high water hardness (hardness category II or higher) you should use water softener. Pay attention to the manufacturer's instructions. Always then meter detergent for hardness category I (= soft). The responsible water works can provide information on the local water hardness.



Water Hardness Details

Hardness Category	Water Hardness °dH (degrees German hardness)	Water Hardness in mmol/l (millimol per litre)
I – soft	0 - 7	up to 1.3
II – medium hard	7 - 14	1.3 - 2.5
III – hard	14 - 21	2.5 - 3.8
IV – very hard	over 21	over 3.8

Running a Wash Cycle



Brief Instructions

To run a wash cycle:



-  1. Open the door and fill with washing.
2. Close the door.
3. Add washing detergent / care agent.
4. Set the wash programme
 - Set the programme using the programme knob;
 - Set the temperature using the temperature selector;
 - Set any additional programme required.
5. If necessary, change the spin speed or select  (RINSE HOLD). You can alter this setting and the temperature at any time during the wash.
6. Press  (ON/OFF) button. Power indicator light comes on. The washing machine has been switched on. The wash programme will start.

When the wash programme has been completed:

Important! If the wash cycle ends on rinse hold run  15 (PUMP OUT) or Position 5 or 10 (SPIN) before opening the door.

-  For safety reasons, the door remains locked for 1-2 minutes after the end of the programme.
7. Open the door and remove the washing.
8. Press  (ON/OFF) button. The power indicator light will go out. The washing machine is switched off.

Add the washing

-  For the maximum filling quantities, see the "Program tables". See "Sort and prepare washing" for information on correctly preparing the washing.
-  1. Sort and prepare the washing according to type.
2. Open the filling door: Pull on the handle of the filling door.
3. Fill with washing.

Important! When closing the door, make sure no items of washing get stuck! This could damage textiles and the unit.
4. Close the filling door securely.

Add Washing Detergent and/Care Agent

i Refer to the information on washing detergents and care agents, see section entitled "Washing Detergents and Care Agents".

- 1.** Pull out the washing powder drawer as far as it will go.
- 2.** Fill with washing detergent / care agent

Compartment for in-wash stain treatment

only for additional programme

 (STAIN)

Compartment for main wash detergent (powder only) and water softener if required

(If you are using water softener, add it to the main wash detergent.)



Compartment for liquid care agent

(Conditioner, finisher, starch)

Important! Do not fill the compartment above the MAX mark. If necessary, dilute viscous agent up to the MAX mark, and dissolve starch powder.

Note: It is normal for a small amount of water to be left in the compartment for liquid care agent; this will not affect the wash results.

Compartment for pre-wash detergent/soaking agent

only for  (PRE WASH) or  (SOAKING) programmes

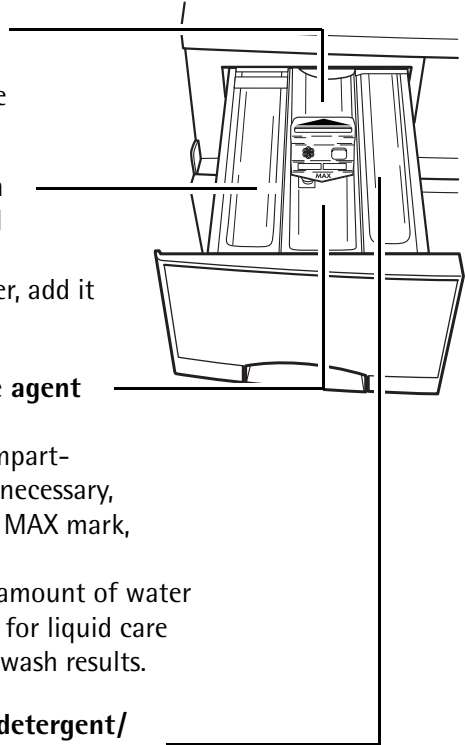

- 3.** Push the drawer in fully.

i If using liquid detergent / tablets:

Use containers supplied by the detergent manufacturers to add liquid detergent or tablets. Follow the instructions on the washing detergent package.

Setting the Wash Programme

i For a suitable programme, the right temperature and possible additional programmes for the relevant type of wash, refer to the "Programme Tables".

Important! Only turn the programme knob in a clockwise direction.



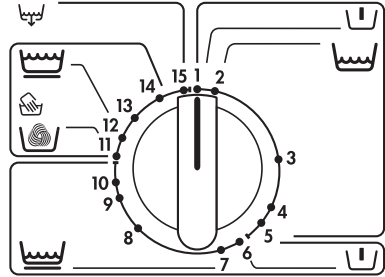



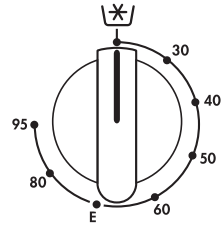



1. Set the programme knob to the desired wash programme.



2. Set the temperature selector to the desired temperature.



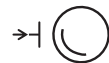

3. Select additional programme if required:

-  (SOAKING) may be used in conjunction with programme knob settings:
 -  **1** (PRE WASH COTTONS/LINEN);
 -  **6** (PRE WASH EASY-CARES).
-  (STAIN) may be used in conjunction with programme knob settings:
 -  **1** (PRE WASH COTTONS/LINEN);
 -  **2** (COTTONS/LINEN);
 -  **6** (PRE WASH EASY-CARES);
 -  **7** (EASY-CARES).
-  (QUICK WASH) may be used in conjunction with programme knob settings:
 -  **2** (COTTONS/LINEN);
 -  **7** (EASY-CARES).



Changing the Spin Speed/Selecting Rinse Hold





-  If required, change the spin speed for the final spin speed or select  (RINSE HOLD):
- Press the spin speed button or
 - press  (RINSE HOLD) button.



If  (RINSE HOLD) is selected the washing will remain in the last rinse water; it will not be spun.





 If the set spin speed is too high for the selected wash program, the final spin speed will be adjusted automatically:

-  (COTTONS/LINEN) 700 revolutions per minute
-  (EASY-CARES) 700 revolutions per minute
-  (DELICATES) 650 revolutions per minute
-  (WOOLLENS) 700 revolutions per minute

The speed of the intermediate spin is dependent on the program selected and cannot be changed.

Start the Wash Programme

-  **1.** Check that the water valve is open.
- 2.** Press the  (ON/OFF) button. The power indicator light will come on.
The washing machine has been switched on. The wash programme will start.



Wash Programme Progress

Programme progress display

The programme knob is also a programme progress display. It turns clockwise as the programme progresses until it ends, showing the stage of the programme that is currently being carried out. The speed at which the programme knob turns varies.

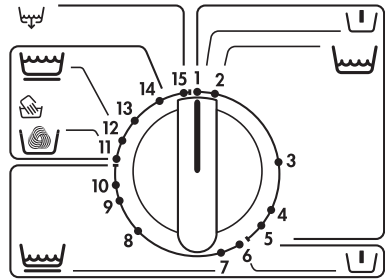

Changing/Interrupting the Wash Programme



Changing settings

While the wash programme is in progress you can

- change the spin speed
-  (RINSE HOLD);

To select a different programme you must first interrupt the programme that is running and then re-set.





Interrupting the wash programme

1. Press the  (ON/OFF) button. The power indicator light will go out.
2. Turn the programme knob clockwise either to  15 (PUMP OUT) or to Position 5 or 10 (SPIN).
3. Press the  (ON/OFF) button again. The power indicator light will come on.
Water is:
 - pumped out or
 - pumped out and the washing then spun.

Wash Cycle Completed/Removing Washing



A wash programme normally ends with the final spin.

If  (SOAKING) has been selected:

-  Release  (SOAKING) button. Main wash for  (COTTONS/LINEN) or  (EASY-CARES) will run.

If  (RINSE HOLD) has been selected:

The water must first be pumped out or the washing must still be spun.

-  Either release the  (RINSE HOLD) button (water is pumped out and the washing spun according to the programme that has been run; the spin speed can still be changed even during the spin),
or
turn the programme knob clockwise to  15 (PUMP OUT) (water is pumped out without spinning),
or
turn the programme knob clockwise to Position 5 or 10 (SPIN) (the water is pumped out and the washing spun at the set speed; the spin speed can still be changed even during the spin).

Once the programme is completed:

-  For safety reasons, the door remains locked for 1-2 minutes after the end of the programme.







































1. Open the door.
2. Remove the washing.
3. Press the  (ON/OFF) button. The power indicator light will go out. The washing machine is switched off.
4. Close the water valve.
5. Pull the washing powder drawer out slightly to allow it to dry. Leave the door just slightly ajar so that the washing machine can air.

Important! If the washing machine is not used for a long time: Close the water tap and disconnect the washing machine from the electricity mains.

Programme Tables

Not all possible settings are listed below - only the most appropriate and those most commonly used in everyday operation.

Washing

Type of Washing, Care Symbols	Maximum Filling Quantity (dry weight) ¹	Programme Knob	Temperature Selector	Additional Buttons Possible
Cottons 	5 kg	 (PRE WASH COTTONS/LINEN)	60 to 95	 (SOAKING)  (STAIN)
		 (COTTONS/LINEN)	60 to 95	 (STAIN)  (QUICK WASH)
Energy-saving programme: Cottons 	5 kg	 (PRE WASH COTTONS/LINEN)	E	 (SOAKING)  (STAIN)
		 (COTTONS/LINEN)		 (STAIN)  (QUICK WASH)
Linen  	5 kg	 (PRE WASH COTTONS/LINEN)	30 to 60	 (SOAKING)  (STAIN)
		 (COTTONS/LINEN)	30 to 60	 (STAIN)  (QUICK WASH)
Easy-cares  	2.5 kg	 (PRE WASH EASY-CARES)	30 to 60	 (SOAKING)  (STAIN)
		 (EASY-CARES)	30 to 60	 (STAIN)  (QUICK WASH)
Delicates 	2.5 kg (or 15-20m ² net curtains)	 (DELICATES)	 (COLD) to 40	
Woolens / Hand Wash   	2 kg	  11 (WOOLLENS)	 (COLD) to 40	

1) A 10 litre bucket holds approximately 2.5 kg of dry washing (wool).

Separate Rinse

Type of Washing	Max. Filling Quantity (dry weight)	Programme Knob
Cottons/Linen	5 kg	3 (RINSE COTTONS/LINEN)
Easy-cares	2.5kg	8 (RINSE EASY-CARES)
Delicates	2.5kg	13 (GENTLE RINSE DELICATES/WOOLLENS)
Woollens	2 kg	

Separate Conditioning/Starching/Finishing

Type of Washing	Max. Filling Quantity (dry weight)	Programme Knob
Cottons/Linen	5 kg	4 (CONDITIONER COTTONS/LINEN)
Easy-cares	2.5 kg	9 (CONDITIONER EASY-CARES)
Delicates	2.5 kg	14 (CONDITIONER DELICATES/WOOLLENS)
Woollens	2 kg	

Separate Spin

Type of Washing	Max. Filling Quantity (dry weight)	Programme Knob
Cottons/Linen	5 kg	5 (SPIN COTTONS/LINEN)
Easy-cares	2.5 kg	10 (SPIN EASY-CARES)
Delicates	2.5 kg	
Woollens	2 kg	

Cleaning and Care

Control panel

Important! Do not use any furniture cleaning agents or aggressive cleaning agents in order to clean panel and control parts.

- ☞ Wipe control panels with a damp cloth. When doing so, use warm water.

Detergent Drawer

The detergent drawer should be cleaned from time to time.

- ☞ 1. Pull the detergent drawer out as far as it will go.
- 2. Remove the detergent drawer by pulling sharply.
- 3. Take the conditioner insert out of the middle compartment.
- 4. Clean the conditioner insert under running water.

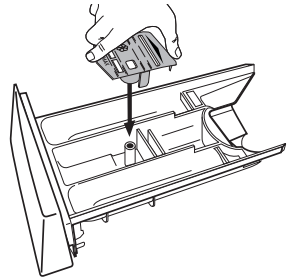

- 5. Clean the compartments with warm water from the rear side. It is best to use a flat brush.

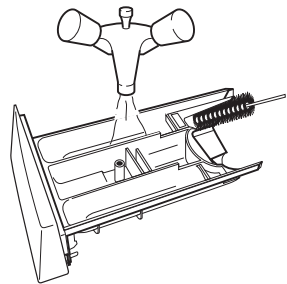

- 6. Push on the conditioner insert as far as it will go so that it is securely in place.

7. Use a brush to clean the entire rinsing-in section of the washing machine, particularly also the nozzles on the top side of the rinsing-in chamber.

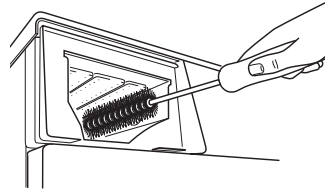

8. Set the detergent drawer into the guide tracks and push in.

Washing Drum

The washing drum is made of stainless steel. Rusting foreign bodies in the washing can cause rust deposits on the drum.

Important! Do not clean the stainless steel drum with decalcifying agents containing acids, scouring agents containing chlorine or iron, or steel wool. Our Customer Service can provide suitable agents.

- ☞ Remove any rust deposits on the drum using a stainless steel cleaning agent.

Main door

- ☞ Check on a regular basis to see if deposits or foreign objects are present in or at the rubber sleeve behind the door, and remove.

Cleaning the drain pump

Paper clips, nails and so on can sometimes get into the washing machine with the washing and remain in the drain pump casing. Fluff and strands of fabric can gather on these items and block the drain pump. Therefore the drain pump should be cleaned at least once a year.



Warning! Switch off the washing machine and pull out the mains plug before cleaning the drain pump!



1. First carry out emergency emptying (see section "Carrying out emergency emptying").
2. Place a towel on the floor in front of the cover of the drain pump. Residual water can run out.
3. Unscrew the drain pump cover anti-clockwise and pull it out.

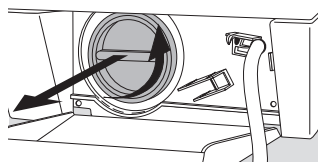

4. Remove any foreign bodies from the pump housing.

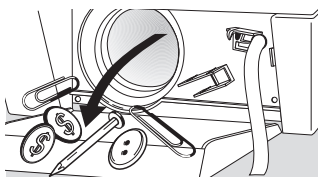

5. Replace the cover. Insert the webs on the cover laterally into the guide slots and screw on the cover securely clockwise.

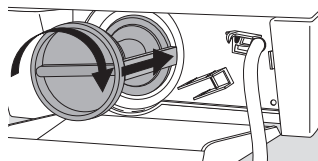

6. Close the emergency emptying hose and place it in the holder.
7. Close the flap.

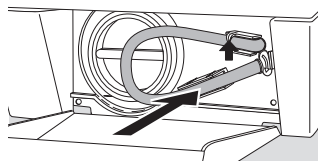



What to do if ...

Remedying Faults

In the event of a fault, try to solve the problem yourself with the aid of the information provided here. If you call Customer Service to deal with one of the faults listed here or to remedy an operating fault, the customer service technician's visit will not be free of charge, even during the warranty period.

Problem	Possible Cause	Remedy
The washing machine does not work.	The mains plug is not plugged in.	Plug in the mains plug.
	The circuit breaker at the household power distribution box has tripped or a fuse at the household fuse box has blown.	Re-set the circuit breaker or replace the fuse.
	The door is not correctly closed.	Close the door; The lock must engage audibly.
The door cannot be closed.	The child safety feature is set.	Cancel the child safety feature (see the section "Child Safety Feature").
The machine does not take in water.	The door is not correctly closed.	Close the door; The lock must engage audibly.
	Water valve is closed.	Open the water valve.
	Filter in screw connection of the inlet hose is blocked.	Close the water valve. Unscrew the hose from the water valve, remove the filter and clean it under running water.
	Water tap is blocked with limescale or is faulty.	Check water tap and have it repaired if necessary.
The washing solution of the main wash produces a great deal of lather.	Too much washing powder/ liquid was probably used.	Use the exact quantities recommended by the detergent manufacturer.

Problem	Possible Cause	Remedy
<p>The washing machine vibrates during operation or wobbles.</p>	<p>The transport packaging has not been removed.</p>	<p>Remove transport packaging according to the installation and connection instructions.</p>
	<p>The height-adjustable screw feet are not correctly set.</p>	<p>Adjust the feet according to the instructions for installation and connection.</p>
	<p>There is very little washing in the drum (e.g. only one dressing gown).</p>	<p>This does not impair the function.</p>
	<p>The water could not be completely pumped out before spinning because the drain hose is bent or the drain pump is blocked.</p>	<p>Check along the drain hose and remove any kinks present, or clean the drain pump and, if necessary, remove foreign bodies from the pump housing.</p>
<p>Water runs out under the washing machine.</p>	<p>The screw connection on the inlet hose is leaky.</p>	<p>Tighten the inlet hose screw connection.</p>
	<p>The drain hose leaks.</p>	<p>Check the drain hose and replace it if necessary.</p>
	<p>The drain pump cover is not correctly closed.</p>	<p>Close cover correctly.</p>
	<p>Washing is stuck in the door.</p>	<p>Interrupt the programme and remove washing from the door. Start the programme again.</p>
	<p>Emergency drain hose is not correctly sealed or is leaking.</p>	<p>Seal the emergency drain hose correctly (see section "Carrying out an Emergency Emptying Operation"). If the emergency drain hose leaks contact customer service.</p>
<p>The washing machine does not spin; there is water in the drum.</p>	<p> (RINSE HOLD) has been selected.</p>	<p>Cancel .</p>
	<p>Soaking programme has finished.</p>	<p>Release  (SOAKING) button (main wash programme will follow).</p>

Problem	Possible Cause	Remedy
Softener has not been flushed into machine; drawer  for care agent is filled with water.	The softener insert has not been correctly positioned inside the care agent compartment or is blocked.	Wash the washing powder drawer and position the softener insert firmly.
Washing is heavily creased.	Probably too much washing was packed into the drum.	Follow instructions for the maximum filling quantity (see Programme Tables).
Washing has not been spun properly. Residual water is still visible in the drum.	The drain hose is bent.	Remove the bend.
	Maximum pump head (outlet head 1 m from unit's floor surface) exceeded.	Contact customer service; a retrofit kit is available as a special accessory for pump heads over 1 m.
	Drain pump is blocked.	Switch off the unit and pull out the mains plug. Clean the drain pump.
	Where a siphon is connected: siphon is blocked.	Clean the siphon.
Detergent deposits form in the washing powder drawer.	Water valve is not fully opened.	Open the water valve fully.
	Filter in the screw connection of the inlet hose on the water valve or on the unit is blocked.	Close the water valve. Unscrew the inlet hose from the water tap and from the unit. Clean the filter.
The rinsing water is murky.	The cause is probably a washing powder/liquid with a high silicate content.	No negative influence on the rinse results; perhaps use liquid washing agent.
Door cannot be opened.	Door is locked for safety reasons.	Wait for 1 or 2 minutes after the end of the programme.

If the washing results are not satisfactory

If the washing has turned grey and if limescale is deposited in the drum, then

- Too little detergent was used.
- The wrong detergent was used.
- Special soiling was not pre-treated.
- Program or temperature not set correctly.
- If multi-component detergents are used, the individual components were not used in the correct ratio.

If there are still grey spots on the washing,

- Washing soiled with ointments, grease or oils was washed with too little detergent.
- Too lower temperature was used for washing.
- A frequent cause is that softener - particularly that in concentrated form - has reached the washing. Wash out such spots quickly and use the softener concerned carefully.

If at the end of the last rinse foam is still visible

- Modern detergents can also cause foam in the last rinse. However, the washing is still sufficiently rinsed.

If there are white remnants on the washing

- These are insoluble components of modern detergents. They are not the result of an insufficient rinsing effect. Shake or brush out the washing. In future, perhaps you should turn the washing inside out before washing it. Examine your choice of detergent and if necessary use liquid detergent.

Carrying out emergency drainage

- If the washing machine no longer pumps off the washing solution, emergency drainage must be performed.
- If the washing machine is in a room where there is a risk of frost, emergency drainage must be performed if there is a possibility of frost.
In addition: unscrew the inlet hose from the water tap and place it on the floor. Empty the drainage hose.



Warning! Switch off the washing machine before performing emergency drainage and pull out the mains plug.

Caution! The washing solution escaping from the emergency drainage hose may be hot. There is a risk of scalding! Allow the washing solution to cool down before performing emergency drainage.

1. Place a flat collecting vessel in order to collect the washing solution which is draining off.
2. Fold open the flap in the right section of the base outwards and pull it off.

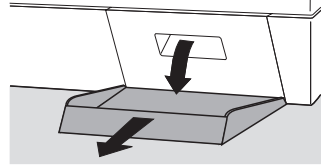

3. Remove the emergency drainage hose from its holder.

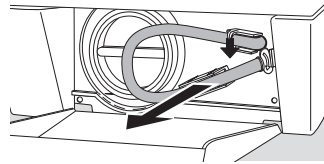

4. Place the container under the hose.
5. Detach the plug of the emergency drainage hose by turning it anticlockwise and pull it out.

The washing solution runs out. Depending on the amount of solution, it may be necessary to empty the collecting vessel several times. To do this, close the emergency drainage hose temporarily with the plug.

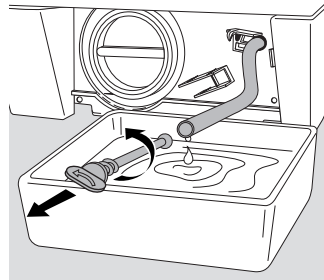

When the water is completely drained:

6. Push the plug securely into the emergency drainage hose and turn it clockwise to secure it.
7. Replace the emergency drainage hose in its holder.
8. Put on the flap and close.

Child Safety Feature

If the child safety feature is set, the filling door can no longer be closed and no washing program can be started.

Setting the child safety feature



Use a coin to turn the rotary knob on the inside of the filling door clockwise as far as it will go.

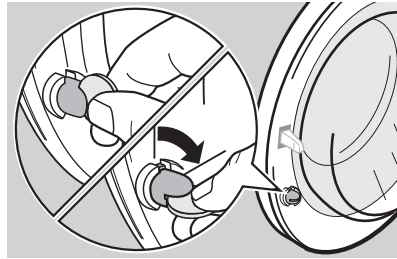

Warning! The rotary knob must not be in a vertical position after adjustment, otherwise the child safety feature is not active. The rotary knob must project as shown in the diagram

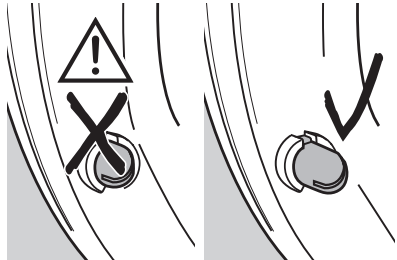

Cancelling the child safety feature



Turn the rotary knob anticlockwise as far as it will go.

Installation and connection instructions

Installation Safety Precautions

- Do not tilt the washing machine onto its front or onto its right side (viewed from the front). Electronic components can get wet.
- Check the washing machine for transport damages. A damaged unit must never be put into operation under any circumstances. In the event of damage, please contact your supplier.
- Ensure that all parts of the transport safeguard are removed and that the unit is splash protected, see "Removing transport safeguard". Otherwise, the units or neighbouring furniture can be damaged when spinning.
- Always insert the plug into a correctly installed earthed socket.
- In the case of permanent connection: A permanent connection may only be made by an authorised specialist.
- Before putting the machine into operation, ensure that the mains voltage and current type shown on the unit's rating plate correspond with those at the place where the machine is being installed. The fuse rating is also found on the rating plate.
- The mains lead may only be replaced by the customer service or by an authorised electrician.

Installation of the appliance

i Washing machines with curved panels are not suitable for installing under units.

Transporting the appliance

- Do not place the washing machine on its front or on its right side (viewed from the front). Otherwise, electrical components can get wet.
- Never transport the unit without the transport safeguard. Do not remove the transport safeguard until the appliance is at the installation location. Transporting the unit without the transport safeguard can damage it.
- Lift the appliance neither by an open filling door nor by the base.
- When transporting the unit with a sack trolley: Attach the sack trolley only at the side.

Remove transportation protection

Important! It is essential to remove the transport safeguard before putting the unit into operation. Keep all parts of the transport safeguard in a safe place for possible later transport (moving).

- i** 1. Open both hose holders on the unit's rear side and remove the hoses and mains cable.

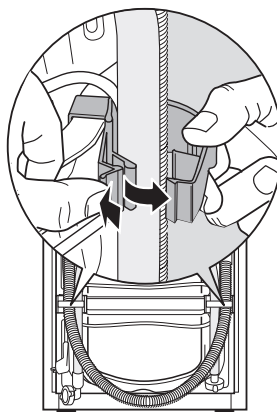

2. Pull both hose holders off the unit with a strong pull.

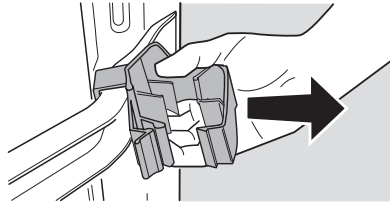

The special key E and the caps D (2 each) and G (1 each) are supplied with it.

3. Unscrew the two screws with the special spanner.
4. Unscrew the 4 screws B with special spanner E.
5. Remove the transport rail C.
6. Screw the 4 screws B back in.
7. Close the 2 large holes with the caps D.

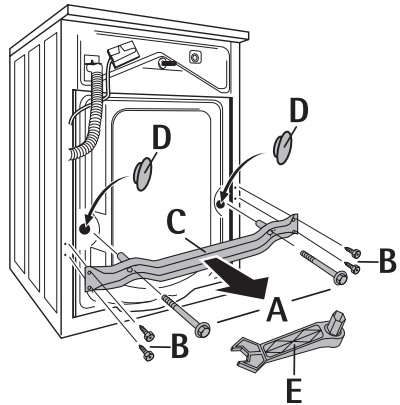

Important! Press in the caps with sufficient strength so that they engage in the rear panel (protects the inside of the units against splash water).

8. Remove the screw F, including the compression spring, with the special spanner E.
9. Close the hole with the cap G.

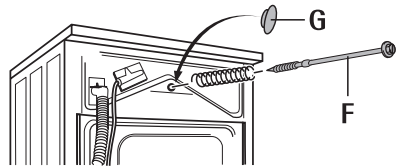

Important! Press in the cap with sufficient strength so that it engages in the rear panel (protects the inside of the unit against splash water).

Prepare the installation place

- The installation surface must be clean and dry, free of floor polish residues and other greasy coatings so that the unit does not slip away. Do not use lubricants as a sliding aid.
- Installation on a high-veil carpet or floor tiles with soft sponge backs is not recommended because the standing safety of the appliance is then no longer ensured.
- By installation surfaces with small-format tiles, lay a conventional rubber mat underneath.
- Minor unevenness of the floor surface should never be levelled out by laying pieces of wood, card or similar materials, but rather should always be compensated for by adjusting the screw feet.
- If, for space reasons, it is not possible to avoid setting up the unit directly next to a gas or coal-fired cooker: install a thermal insulation panel between the cooker and washing machine (85 x 57cm) which must have an aluminium film on the side against the cooker.
- The washing machine must not be set up in a room where there is a danger of frost. Frost hazard!
- Flexible feed and drain tubings may not be crinkled or squeezed.

Installation on a concrete base

If the unit is set up on a concrete base, for safety reasons it is essential to fit stand plates in which the washing machine is adjusted. The stand plates are available from Customer Service under the spare parts number 645 425 058.

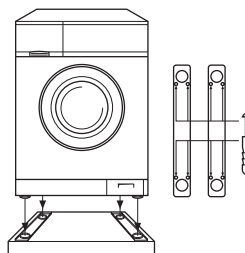

Installation on vibrating floors

Where the floor vibrates, particularly in the case of wooden beam floors with pliable boards, securely screw a water-resistant wooden panel at least 15mm thick onto at least 2 floor planks. If possible, set up the unit in the corner of a room, as the wooden floor is optimally restrained there and is therefore least likely to be subject to resonance vibrations.

Compensate for floor unevenness

Floor unevenness can be compensated for and the height can be corrected with the four adjustable screw feet. The height can be adjusted in the range +10 .. -5mm.

To adjust the feet use the special spanner supplied for removing the transport braces.

-  1. Slide the special key firmly onto the hexagon head of the threaded foot as far as it will go.
2. Adjust the screw feet so that the unit is horizontal and stable. The unit must not wobble over when loaded.
3. If necessary, check the setting with a spirit level.

Important! Minor unevenness of the floor surface should never be levelled out by laying pieces of wood, card or similar materials, but rather should always be compensated for by adjusting the adjustable feet.

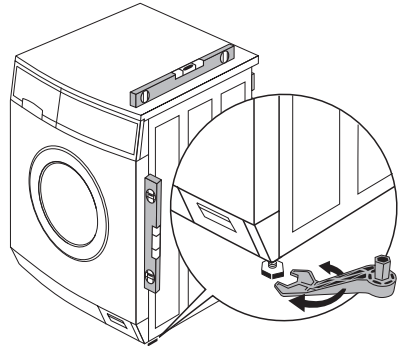

Electrical connection

Details of the mains voltage, current type and required fuses can be found on the rating plate. The rating plate is located at the top above the filling door.

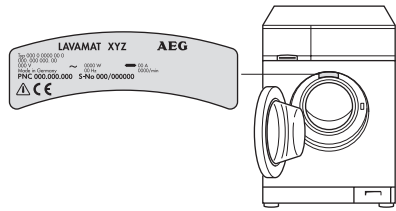

For permanent electrical connection within the electrical circuit, provisions must be made which allow for electrical disconnection of the appliance from the mains with a contact opening of at least 3 mm at all poles. Suitable devices include circuit breakers, fuses (threaded fuses must be entirely removed from the socket), ground fault circuit interrupters and contactors. Permanent connection may only be carried out by an authorised electrician.

- CE** This appliance complies with the following EC directives:
- The "Low Voltage Directive" 72/23/EU with changes
 - The "EMC Directive" 89/336/EU with changes

Water connection

i The washing machine has safety features which prevent back-contamination of the drinking water and which conform to the national regulations of the water authorities (e.g. for Germany: DVGW guidelines). This means that additional protective measures in the installation are not necessary.

Important!

- Units for connecting to cold water must not be connected to hot water.
- Use only new hose sets for the connection.

Permissible water pressure

The water pressure must be at least 1 bar (= 10 N/cm² = 0.1 Mpa), maximum 10 bar = 100 N/cm² = 1 Mpa).

- If more than 10 bar: Connect a pressure-reduction valve upstream.
- If less than 1 bar: Unscrew the inlet hose on the unit side at the solenoid intake valve and remove the flow regulator (to do this, remove the filter with pointed pliers and take out the rubber washer behind). Replace the filter.

Water inflow

A pressure hose of 1.35m in length is supplied.

If a longer inflow hose is required, only a VDE-approved, complete set of hoses with fitted hose screw connections offered by our Customer Service is permissible.

- Hose sets in lengths of 2.2m, 3.5m and 5m are available for washing machines without Aqua-Control.
- Hose sets in lengths of 2.0m, 2.9m and 3.5m are available for washing machines with Aqua-Control.

Important! Never cut into pieces in order to extend the hoses!

i Sealing rings are supplied either in the plastic nuts of the hose screw connection or in the enclosed pack. Do not use other seals!

1. Connect the hose with the angled connection to the machine.

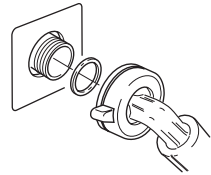

Important!

- Do not lay the inlet hose vertically downwards, instead run it to the right or left as shown in the diagram.
- Tighten the hose screw connection only by hand.

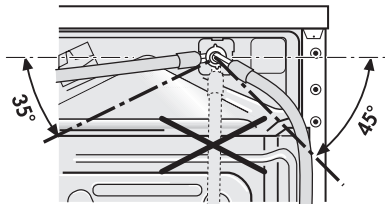

2. Connect the hose with the straight connection to a water valve with a screw thread R 3/4 (inches).

Important! Only tighten the screw connection manually.

3. By slowly opening the water valve before putting the washing machine into operation, check that the connection is free of leaks.

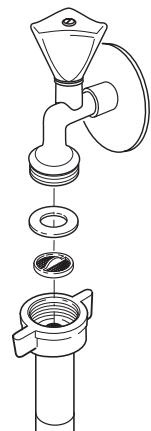

Water drain

The drainage hose can either be connected to a siphon or hung in a wash basin or discharge basin or a bath tub.

Only original hoses may be used for extensions (max. 3m laid on the floor and then up to 80cm high). Customer Service stocks drainage hoses in lengths of 2.7 and 4m.

Important! It is essential to lay the drainage hose without kinks.

Water drain-off inside a siphon

The grommet on the hose end fits all standard siphon types.



Secure the connection between the grommet and siphon with a hose clamp.

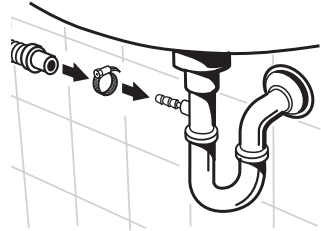

Water drain-off inside a basin

Important!

- Small basins are not suitable for drainage. Water could overflow!
- The end of the drainage hose must not be submerged in the pumped-out water. Otherwise, the water could be sucked back into the unit.
- When hanging in a wash basin or a bath tub, the drainage hose must be secured with the supplied attachable bend to prevent it slipping. The back-surge force of the escaping water could otherwise force the hose out of the basin.

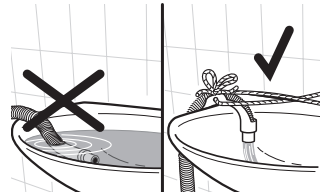

Tie the bend to the tap or the wall using a piece of string.

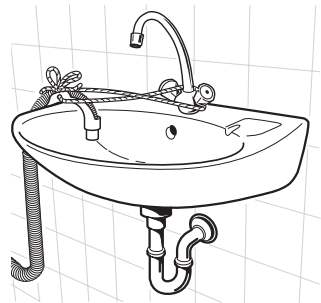

Delivery heads over 1m

To pump off the washing / rinsing solution, every washing machine has a drain pump which carries liquids up to a height of 1m via the drainage hose, calculated from the machine's standing surface.

Please contact Customer Service for delivery heads of over 1m.

Technical data

Adjustment possibility

Filling quantity (program-dependent)

Area of use

Drum speed, spinning

Water pressure

Approx. +10 / -5mm

max. 5kg

Domestic

See rating plate

1-10 bar (= 10 - 100 N/cm²
= 0.1 - 1.0 Mpa)

Dimensions

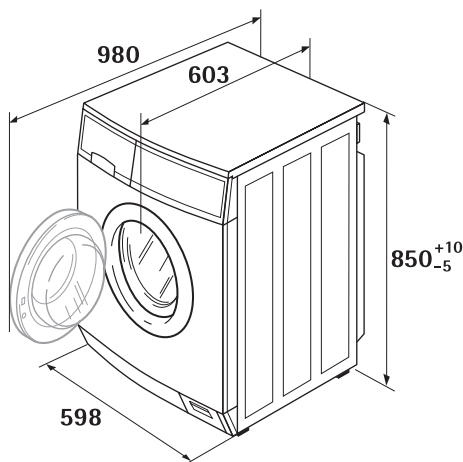

(dimensions in mm)

Warranty conditions / Customer service centres

Weitere Kundendienststellen im Ausland

In diesen Ländern gelten die Garantiebedingungen der örtlichen Partner. Diese können dort eingesehen werden.

Further after-sales service agencies overseas

In these countries our AEG agents' own guarantee conditions are applicable. Please obtain further details direct.

Autres agences étrangères assurant le service après-vente

Dans ces pays, les conditions de garantie des concessionnaires de la région sont valables. Vous pouvez les consulter sur place.

Otros puntos de Postventa en el extranjero

En estos países rigen las condiciones de nuestros representantes locales, las cuales pueden ser consultadas allí mismo.

Ulteriori uffici del servizio tecnico assistenza clienti all'estero

In questi paesi sono valide le condizioni di garanzia dei partner locali. Queste condizioni possono essere esaminate sul luogo.

Serviços de assistência técnica no estrangeiro

Nestes países são válidas as condições de garantia dos concessionários locais, podendo aí ser consultadas.

U.A.E. Abu Dhabi

Universal Trading Company
P.O. Box 43 99
Tel.: 335331

Jordan

Jordan Household
Supply Co. Ltd.
P.O. Box 3/68
Amman/Tel.: 69 70 50

Malta

ITC
International Trading Company
White House Building
Mountbatte Street
Blata L-Bajda/Tel.: 220644

Egypt

Middle East Commercial
Center
P.O. Box 19
Kairo-Heliopolis
Tel.: 29917/31634

Kanada

EURO-LINE Appliances
2150 Winston PARK Drive 20
Oakville, Ontario L6H 5V1
Tel.: 905 829 3980
Fax: 905 829 3985

Mauritius

Happy World Centre Ltd.
P.O. 7 54
1 Chausee Street
Port Louis
Tel.: 25355

Australia

ANDI-Co Pty. Ltd
9 Kingston Town Close
Oakleigh VIC 3166
Tel.: (03) 9569 1235
Fax: (03) 9569 1450

Korea (South)

Core Incorp.
3/F Chewoo Bldg.
200 Nonhyun-Dong
Kangnam-Ku
Seoul
Telefon 82 2 549 89 61

Namibia

AEG NAMIBIA (PTY) LIM-
ITED-Jeppe Street
Northern Industrial Area
Windhoek
Tel.: (061) 21-6082/4
Fax: (061) 217838

Bahrain/Arabian Gulf

A.A. Zayani & Sons
P.O. Box 9 32
Bahrain
Tel.: 261060

Bulgaria

Electrolux Bulgaria E.O.O.D.
91 Levski Blvd.
1000 Sofia
Tel.: 2 806676
Fax. 2 980 5276

Cyprus

Hadjikyrlakos & Sons Ltd.
Prodromou 121
P.O. Box 21587
Nicosia 1511
Service Telephones:
Nicosia 02 481226
Limassol 05 562182
Larnaca 04 633929
Paphos 06 932 699

Estonia

Electrolux Estonia Ltd.
Mustamäe tee 24
EE0006 Tallinn
Tel.: (372) 6 650 090
Fax: (372) 6 650 092

Hongkong

Wo Kee Services Ltd.
585-609 Castle Peak Road
Kwai Chung N.T.
Hongkong
Tel.: 2494 4000

Croatia

Electrolux D.O.O.
Suplova 7
10000 Zagreb
Tel.: 1 61 19512
Fax: 1 61 19513

Kuwait/Arabian Gulf

Ali Al-Ghanim Est.
P.O. Box 10 83
Tel.: 5322463
Fax: 5242114

Lebanon

Adib & Assaferi
P.O. Box 539
Tripoli

Latavia

Electrolux Latavia Ltd.
Terlaton Street 42/44
1011 Riga
Tel.: 371 2 297821
Fax: 371 2 821286

Lthuania

Electrolux Lthuania
Verkui 29
2600 Vilnius
Tel.: 372 272 3326
Fax: 372 272 3366

New Zealand

Euro-Life New Zealand Ltd.
Privat Bag
58 Symonds Street
Auckland
Tel.: (09) 525 2222

Nouvelle Caledonie

Socometra N.C.
B.P. 483
Nouman
Tel.: 275444

Oman

Moshin Haider Darwish
P.O. Box 1 35
Muscat
Tel.: 703743

Poland

Electrolux Poland Sp. zo.o.
ul. Domaniewska 41
02-034 Warszawa
tel.: 022 874 33 33
fax: 022 874 33 00

Russia

Electrolux Russia Ltd.
16 Olympiysky prospekt
129090 Moscow
Tel.: (095) 937 7837
Fax: (095) 926 5513

Israel

Electricity & Electronic
Services-Evis LTD.
19 Hataasia st.
Raanana,
Industrial area 43654
Tel: 972-9-7448118
Fax: 972-9-7603618
e-mail: evlis@evlis.co.il

Malaysia

Arzbergh Engineering
No. 49A/B, Jalan Petaling
Utama 7
4600 Petaling Jaya
Tel.: 3 795 1084
Fax: 3 795 1082

Saudi Arabia

Alia Trading Corporation
P.O. Box 4101
King Abdul Aziz Street
Riyadh
Tel.: 4645977
Al Nahas Est.
Musaidia Market I
P.O. Box 1 15 29
Jeddah
Tel.: 6606852

Japan

Electrolux Japan Ltd.
Yasuda Warehouse 4F 3-3-12
Heiwajima Ota-Ku
Tokyo
Tel.: 81 3 3544 3363
Fax: 81 3 3763 6143

Singapore

Arzbergh Engineering
19 Tanglin Road 06-07
Singapore 247909
Tel.: 65 7356572
Fax: 7351124

Slovenia

Electrolux Slovenia D.O.O.
Traska Ul. 132
1000 Ljubljana
Tel.: 61 1234 137
Fax: 61 1234 238

Thailand

OLYMPIA Thai Ltd.
44 Ratchadapisek Road
10320 Bangkok
Tel.: 2 513 6111
Fax: 2 513 2574

Slovakia Rep.

Electrolux Slovakia S.R.O.
Seberiniho 1
821 03 Bratislava
Tel.: 02 4333 4322, 4355
Fax: 02 4333 6976

South Africa

AEG (Pty) Ltd.
55, 12th Road
P.O. Box 1 02 64
Kew/Johannesburg 2000
Tel.: 8069111

Hungary

Electrolux Lehel KFT
(AEG Div)
Erzsebet'Kiralyné Utja 87
1142 Budapest
Tel.: 00361/251 84 44

USA

ANDI Co. Appl. Inc. East
65 Campus Plaza
Edison, New Jersey 0837
USA/Tel.: (201) 2258839

Syria

Masri & Shami
P.O. Box 24 96
Damascus
Tel.: 214080

INDEX

C

- Care agent 9, 17, 19
- Care symbols 16
- Child safety feature 29, 34
- Conditioner 9, 19
- Conditioning 11, 12, 25
- Cottons 10, 16, 24, 25
- Curtains 15
- Customer Service 27, 29, 51

D

- Delicates 11, 16, 24, 25
- Detergent 9, 17, 19
- Detergent drawer 9, 19
- Drain pump 9, 28

E

- Easy-cares 11, 16, 24, 25
- Eco-sluice 14
- Emergency drainage 32
- Energy-saving programme 12, 24

F

- Filling quantity 14, 24

G

- Gentle rinse 12

I

- In-wash stain treatment 9, 19

L

- Linen 10, 16, 24, 25

M

- Main wash 10, 24

N

- Net curtains 24

O

- Opening the door 18, 23, 31

P

- Pre wash 10, 11, 19, 24
- Pre-wash detergent 9, 19
- Programme
 - changing 22
 - interrupting 22
 - setting 20, 24
- Programme progress display 22
- Pump out 12, 18, 22, 23

Q

- Quick wash 13, 20, 24

R

- Rating plate 9, 40, 51
- Rinse 11, 25
- Rinse hold 11, 18, 21, 22, 23
- Risk of frost 6, 32

S

- Silk 16
- Soaking 12, 19, 20, 23, 24
- Soaking agent 19
- Spin 11, 18, 21, 22, 25
- Stain 8, 13, 20, 24, 32
- Starching 11, 25

W

- Warranty 6, 29, 44
- Washing
 - coloureds 15
 - heavily soiled 13
 - lightly soiled 8, 13
 - normally dirty 8
 - sensitive 16
- Water
 - hardness 8, 17
 - pumping out 12, 18, 22, 23
 - softener 8, 17, 19
- Woolens 11, 16, 24, 25

Service

In the chapter "What to do if..." , some faults are listed which you can remedy yourself. Look there first if a fault occurs. If you do not find any information there, please consult your Customer Service. (You can find the addresses and telephone numbers in the section "Customer Service Centres".)

Always prepare in advance for the discussion. By doing so you will simplify the diagnosis and the decision on whether customer service is necessary.

Note the PNC number and S. number. You will find both on the rating plate on the inside of the door of your washing machine.

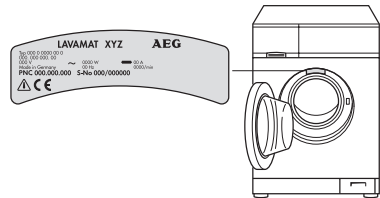

PNC

S. No.

Answer as precisely as possible:

- What form does the fault take?
- Under what circumstances does the fault occur?

When do you incur costs even during the warranty period?

- If you could have remedied the fault yourself with the aid of the fault table (see the section "What to do if..."),
- If several journeys by the customer service technician are necessary because for example he did not receive all the important information before his visit and must collect spare parts. These multiple trips can be avoided if you prepare your phone call as described above.

AEG Hausgeräte GmbH
Postfach 1036
D-90327 Nürnberg

<http://www.aeg.hausgeraete.de>

© Copyright by AEG

822 942 808-01-140302-05

Subject to change without notice